

Features

- With overflow.
- For use in overflow applications.

Material

- Solid-brass construction for durability and reliability.
- KOHLER finishes resist corrosion and tarnishing.

Recommended Products/Accessories

- K-23726 Drain treatment
- K-23723 Faucet cleaner



Codes/Standards













ASME A112.18.2/CSA B125.2

KOHLER® One-Year Limited Warranty

See website for detailed warranty information.

Available Colors/Finishes

Color tiles intended for reference only.

Color	Code	Description
	CP	Polished Chrome
	SN	Vibrant® Polished Nickel
	AF	Vibrant® French Gold
	PB	Vibrant® Polished Brass
	BN	Vibrant® Brushed Nickel
	VS	Vibrant® Stainless
	BV	Vibrant® Brushed Bronze
	2BZ	Oil-Rubbed Bronze
	BL	Matte Black
	2MB	Vibrant® Brushed Moderne Brass
	TT	Vibrant Titanium
	VNT	Vintage Nickel

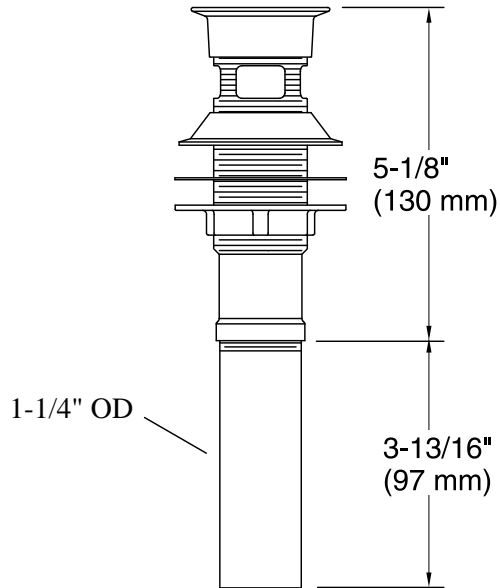
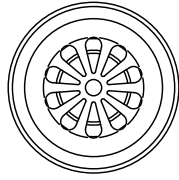

Technical Information

All product dimensions are nominal.

Notes

Install this product according to the installation guide.